

VIMLE

1

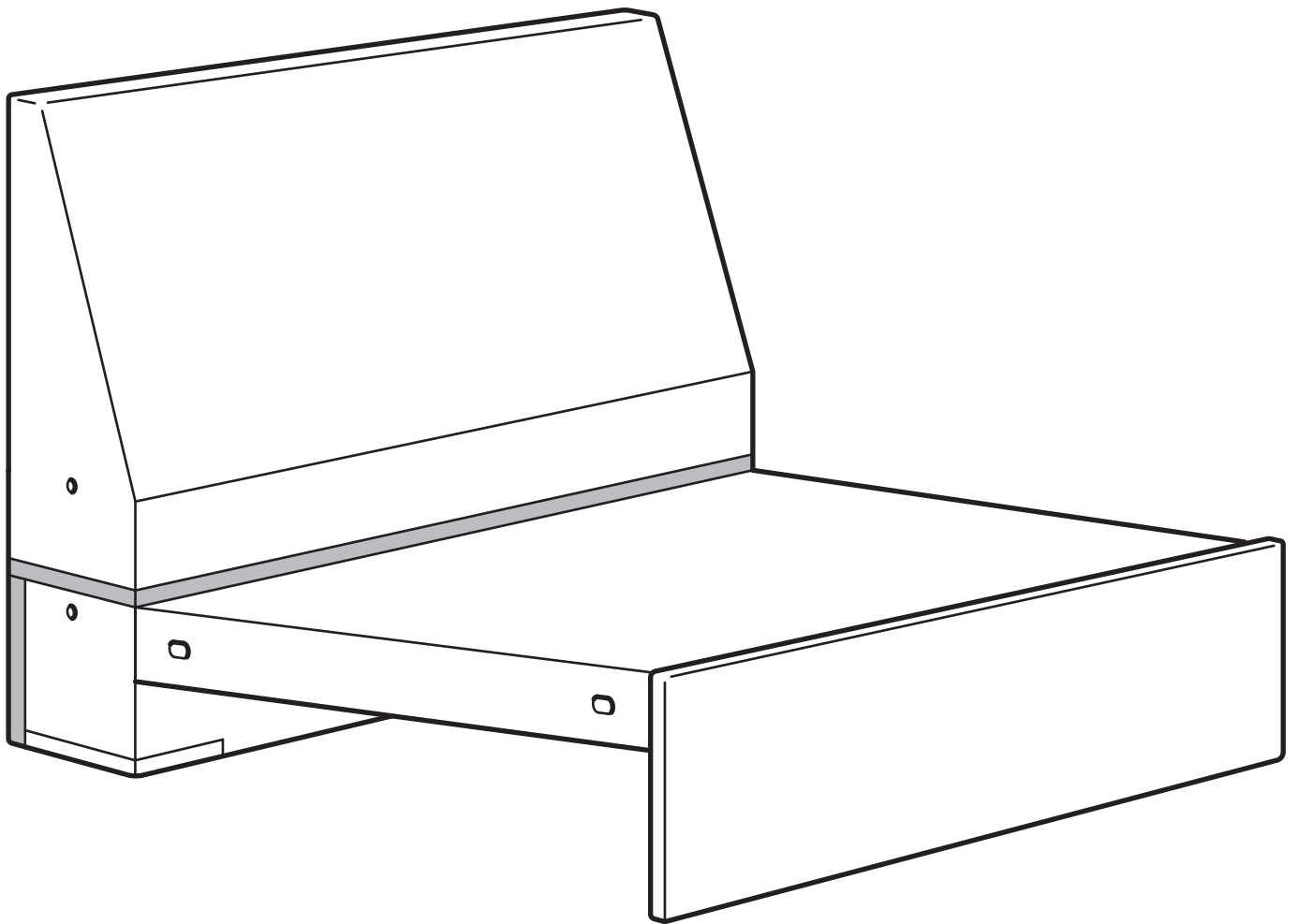

Design and Quality
IKEA of Sweden

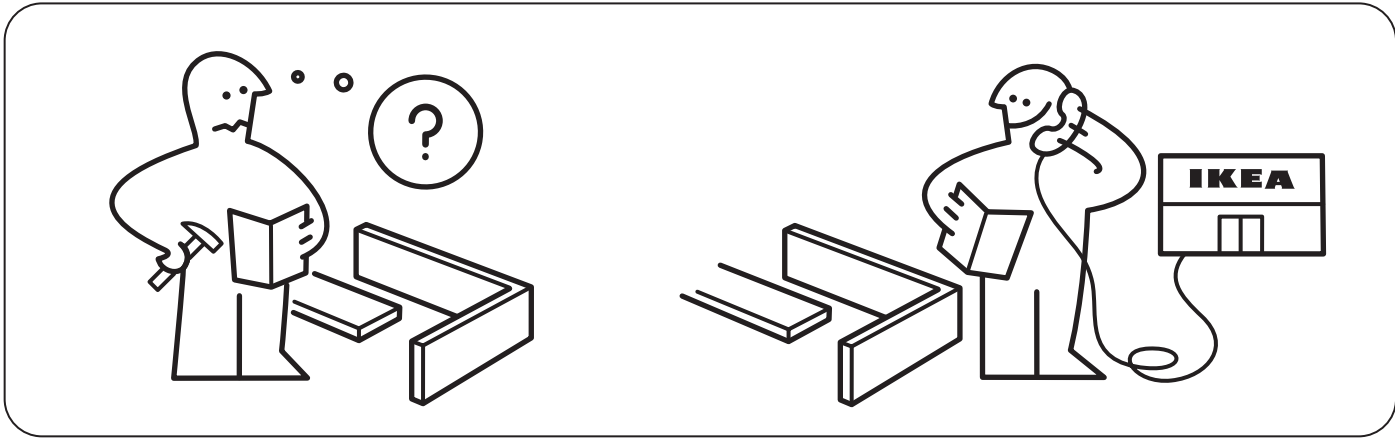
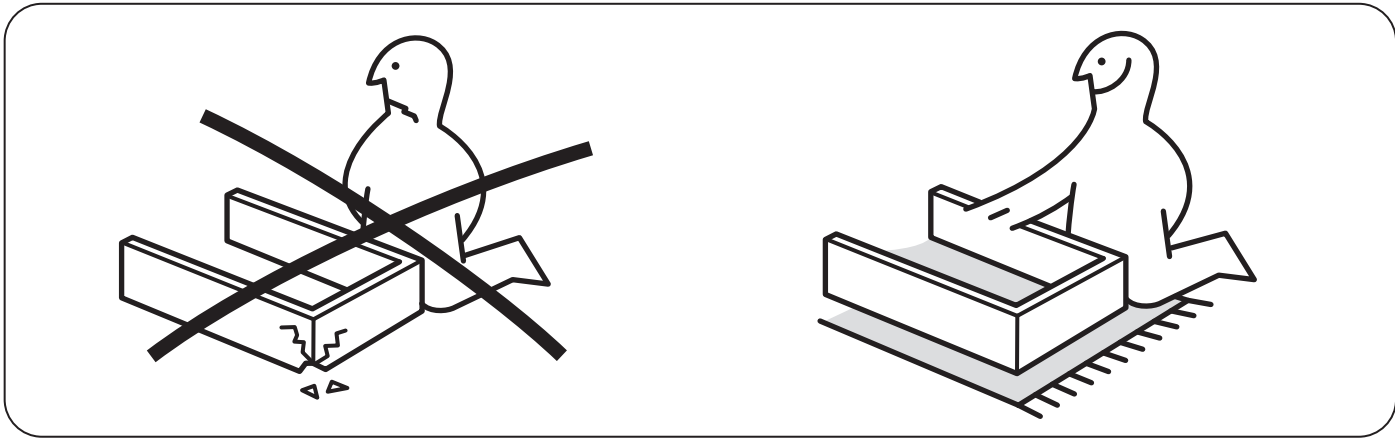
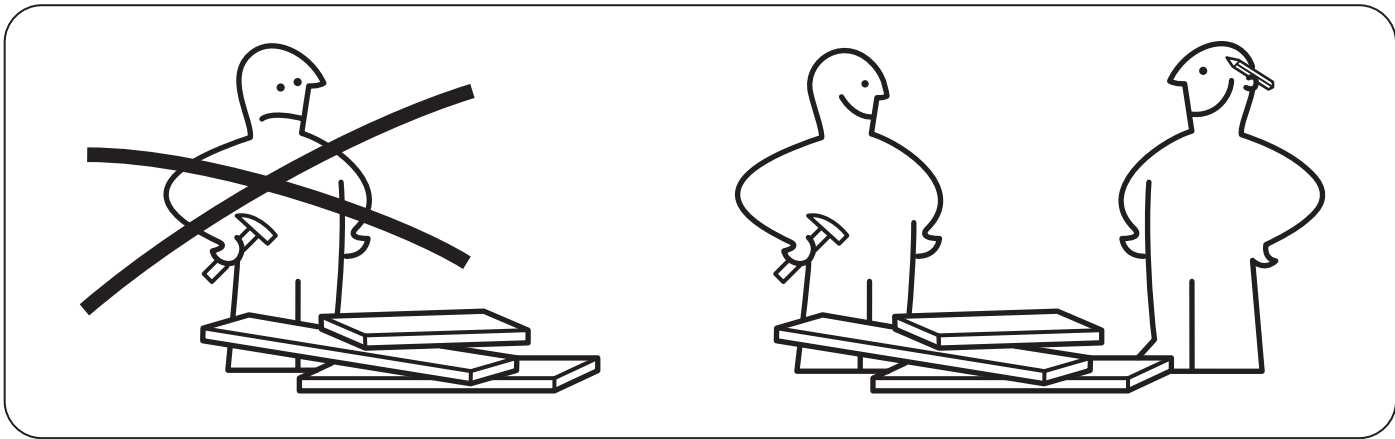

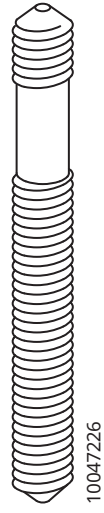

2x

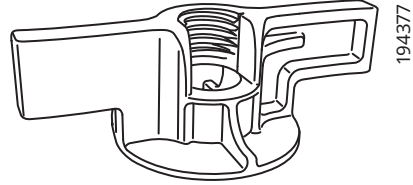

2x

1

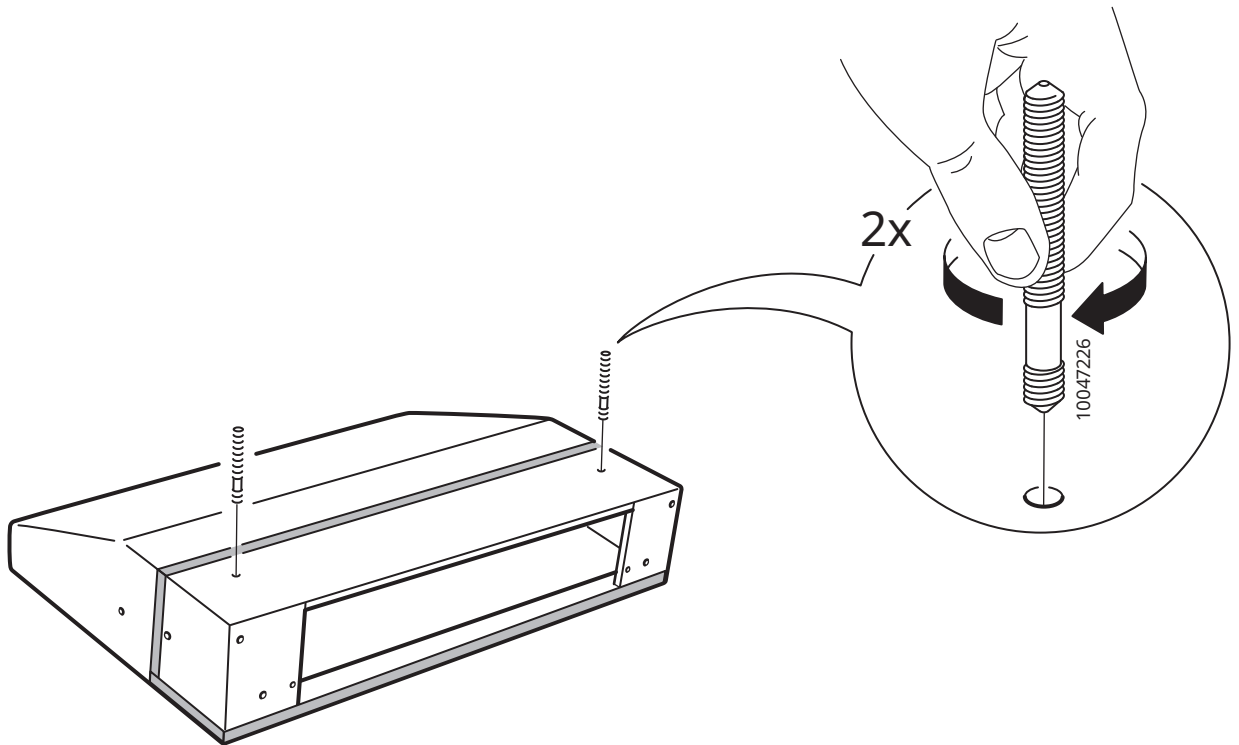

2

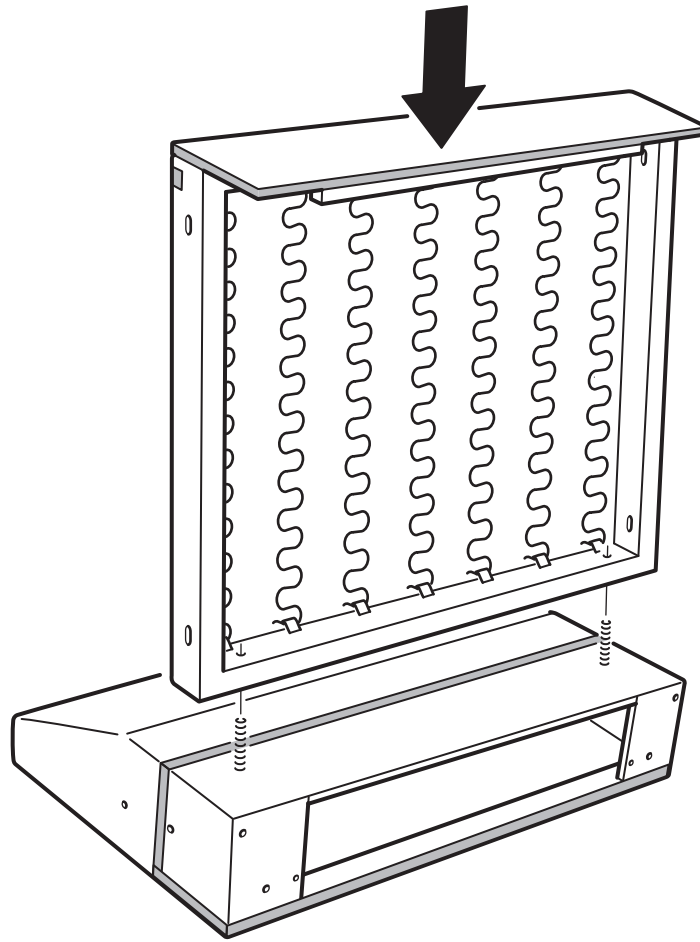

3

